

# OPERATING INSTRUCTIONS



# McDONALD 610

## IMPORTANT

Read these instructions carefully before operating your unit.

## UNPACKING

Remove turntable from carton. Carefully detach foam supports from turntable base and remove all protective coverings, tape, etc. Carton packing material and inserts have been designed for the safe handling of your automatic turntable. You should retain them for future transportation.

**CAUTION:** When repacking unit for shipment, make sure that tone arm "A" is securely fastened to locking rest-post "B" by means of strong tape. Do not depend on rest-post only as this is not designed for shipping purposes. We cannot be responsible for shipping damages to cartridge stylus or unit due to tone arm being improperly secured.

### 1. TRANSIT SCREWS (Refer to Figs. 6 and 7)

Float unit by turning transit screws "C" clockwise until fully "DOWN" against baseplate. To prepare unit for transit, rotate transit screws "C" counterclockwise until unit is firmly secured to mounting base. An aluminium cap "R" is supplied to fit into the Control Panel "D" when the transit screw is in the lowered position.

### 2. CONTROL ARM (Refer to Fig. 7)

Release control arm "E" from transit lock position as follows: Unlock control arm by pressing down at the rear above the housing and rotate the front free end towards the center of the turntable. Failure to follow this procedure will result in damage to the control arm.

### 3. CAST TURNTABLE INSTALLATION

- Set control knob "I" to "STOP" position.
- Set speed selector knob "T" to 33 rpm.
- Lift control arm "E" and swing to right.
- Remove turntable "F" from polyfoam pack. Do not try to install or remove turntable with spindle "O" or "P" in place.
- Gently place turntable over center bearing.
- Save turntable packing material in event unit must be reshipped for any reason.

**CAUTION:** Never ship or turn unit upside down without first removing the cast turntable.

## ADJUSTMENTS

Do not connect unit to A.C. outlet until adjustments are made.

### 1. PICKUP ARM BALANCE (Refer to Fig. 1 and 2)

- Rotate the turntable "E" clockwise by hand five times to ensure that it is free and the mechanism is in the neutral position.

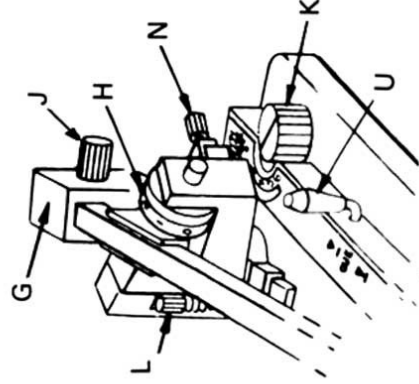

Fig. 1

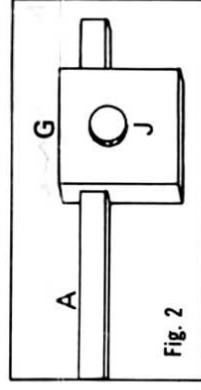

Fig. 2

- Place counter balance weight "G" on rear of tone arm as shown in Fig. 2. Be certain that knob of counter weight points to the right side of unit and that the larger portion is hanging below the tone arm.
- Rotate stylus pressure dial "H" Fig. 1, until "0" coincides with marked line on pickup body.

## IMPORTANT:

### STYLUS PRESSURE AND ANTI-SKATE SETTING

- Set stylus pressure dial to:  
  $\frac{3}{4}$  — 1½ grams  
 1½ — 2 grams  
 2 — 3 grams  
 3 — 5 grams  
 6 grams
- Set Anti-Skate control to same setting as used in a).  
Use:  Elliptical Scale  
 Conical Scale

## POWER BASE INSTRUCTIONS

### 610/X TOTAL TURNTABLE

Your unit is equipped with the decorative power base. Please read these instructions carefully. Your decorative base is designed to allow your automatic turntable to control the power to your amplifier and/or receiver through the automatic last record shutoff of your turntable or manually by means of a switch. This eliminates possible damage to your system caused by its staying on, long after the turntable shuts off.

### BASE POWER CONNECTIONS

Plug the A.C. cord of your 120 volts AC/60 HZ amplifier or receiver into the A.C. socket at rear of base and plug the A.C. power cord from the turntable into the 120 volts A.C. wall outlet. Turn knob of amplifier/receiver to "on".

### AUTOMATIC SHUTOFF

Press rocker switch on front of base to "ON" position. Starting turntable will furnish power to amplifier or receiver. After last record has played, the turntable will shut off and also shut off the amplifier/receiver. To start again, just switch turntable "ON".

### MANUAL OPERATION

To use your amplifier/receiver without the turntable being on, or if you do not want automatic system shutoff, press rocker switch to "OFF" position.

## CUSTOM BASE DECORATION

A walnut vinyl inlay is included with your base so that you can add a touch of walnut if you desire.

## ACCESSORIES

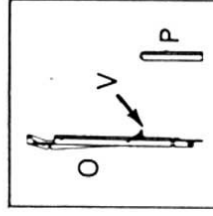

Fig. 4  
Automatic and  
Manual Spindle

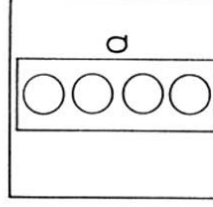

Fig. 5  
Cork Feet  
For Mounting Base

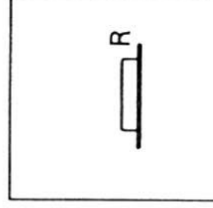
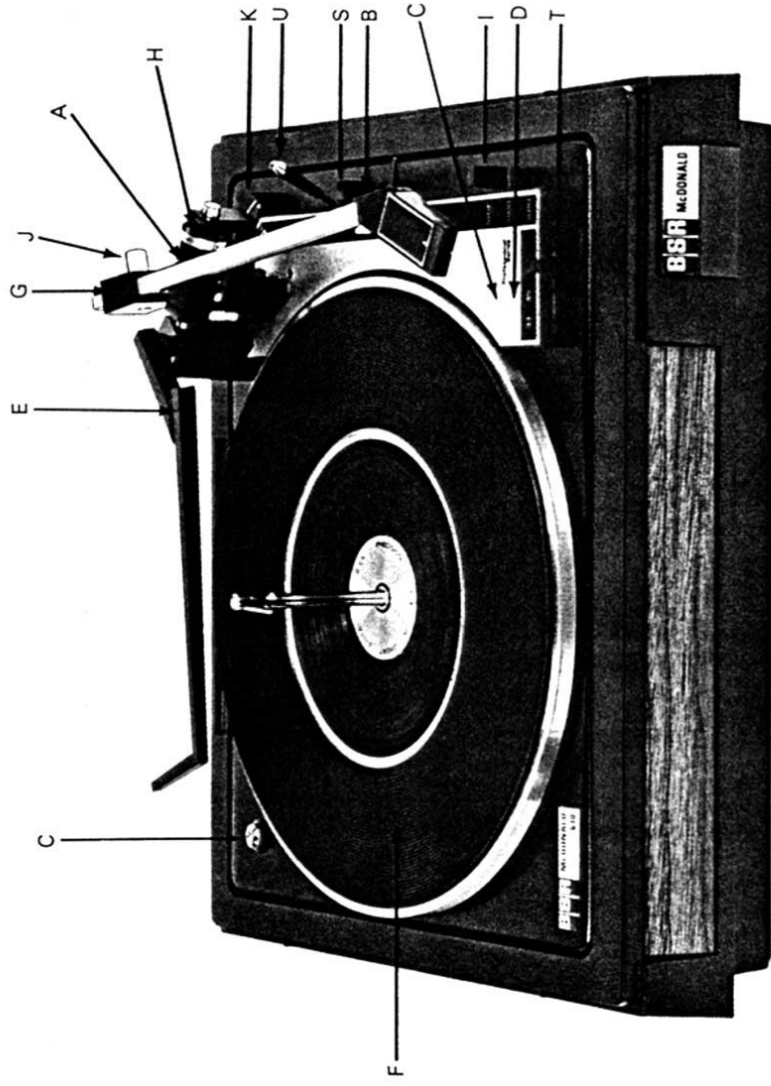

Fig. 6  
Decorative  
Cap



For replacement of PS 899 45 rpm adaptor or above accessories, please write to: BSR (USA) LTD., Route 303, Blauvelt, New York 10913.

D) Slide control knob "I" to "START" and leave in that position.

E) Place tone arm carefully towards the middle of the turntable and rotate balance adjusting knob "J" to move counter weight along the tube until arm balances with tube parallel to turntable surface.

## 2. POWER CONNECTION

Plug power cord into any convenient 120 volts, 60 HZ. A.C. outlet. Attach separate ground lead to suitable "ground" on your amplifier. This automatic turntable operates satisfactorily on a line voltage of 105-130 volts A.C.

## 2. STYLUS PRESSURE (Refer to Fig. 1)

When counter balance is complete, place tone arm back into the locking rest-post and slide control knob to "STOP". Rotate stylus pressure dial "H" until the figure for the appropriate stylus pressure in grams coincides with the marker line.

**NOTE:** Set the stylus pressure to that recommended on bottom of page 1.

## 3. ANTI-SKATE CONTROL (Refer to Fig. 1)

This control should always be set for the same value as the stylus pressure. The control is operated by turning anti-skate knob "K" so that the desired number lines up with the indicator line on anti-skate knob. Different scales are provided for elliptical and conical styli. Be sure to use the proper scale as bias compensation requirements for these types of styli differ considerably. The proper scale for elliptical styli is designated by the symbol "●". For conical styli, use scale designated by the symbol "●". For correct setting see bottom of page 1. For intermediate values, position skate knob so that the indicator lines up between the approximate value.

**EXAMPLE:** For 3½ gram value, position knob so that indicator is midway between "3" and "4" on proper scale.

**NOTE:** Variation from the settings described may be necessary depending on the condition of the stylus. If, after adjustment, the tone arm tends to skate out, lower the setting. If it skates inward, increase the setting. Incorrect bias compensation may be evidenced by a visual tilt to the stylus or audible distortion.

## 4. TONE ARM HEIGHT (Refer to Fig. 1)

When unit cycles, bottom edge of tone arm should clear top of rest-post "B" by 1/16" before setting into rest. If the pickup height is set too high, adjust by turning height adjustment screw "L" clockwise to lower and if too low, turn counterclockwise to raise.

## 5. STYLUS SET DOWN (Refer to Fig. 1)

The stylus set down is correct when the stylus sets down 1/8" in from the edge of the selected size of record. If adjustment is necessary, turn set down screw "N" to move tone arm inwards or out for correct set down.

## CONNECTIONS

### 1. PHONO CONNECTION

A twin phono shielded cable is provided with your unit for insertion into the phono input of your amplifier. Use the black plug from unit for right channel and gray plug for left channel. (For monophonic operation, use black plug).

## AUDIO WIRING DIAGRAM

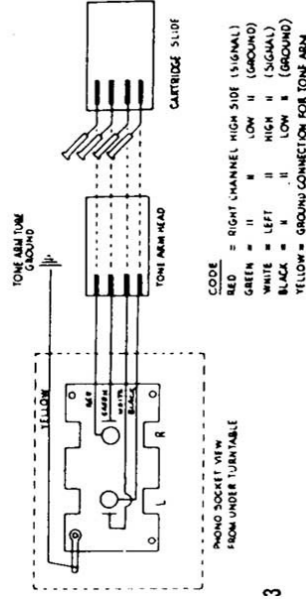

Fig. 3

## AUTOMATIC PLAY

1. Insert automatic spindle "O" fully into the center hole of turntable by rotating the spindle until side projection "V" is engaged in locking slot.
2. Lift control arm "E" and swing to the right above the rest-post.
3. Stack up to 6 records on center spindle holding the stack with the left hand and position control arm over the records.
4. Set control knobs "S" and "T" to correct record size and speed.
5. Make sure cueing lever "U" is in the down position.
6. Start unit by sliding control knob "I" from "STOP" to "AUTO" position, hold momentarily until turntable starts to revolve and then release gently.
7. To reject records, repeat step "6".
8. After last record, tone arm will return to its locking rest-post and unit will shut off automatically.

## SEMI-AUTOMATIC PLAY

1. Lift control arm "E", swing to right above the rest-post and leave in that position.
2. Remove automatic spindle by pulling it upward with a slight counterclockwise twist.
3. Insert short manual spindle "P" into center hole.
4. Place desired record on turntable.
5. Slide control knob "I" from "STOP" to "AUTO" position and let it gently return to "START".
6. Tone arm will set down on record and will repeat playing automatically when record ends.
7. For automatic shut off, after stylus sets down gently return control arm to center and lower to down position. Tone arm will return to rest at end of record and unit will shut off.

## MANUAL PLAY

1. Repeat steps "1" through "4" under semi-automatic play.
2. Return control arm to center and lower to down position.
3. Start unit by sliding control knob "I" from "STOP" to "START".
4. Using cueing lever "U", raise tone arm and position above lead in groove at beginning of record or at any desired band.
5. Lower cueing lever gently to place stylus in groove.
6. Unit will automatically shut off at the end of the record.
7. For a repeat play of the same record, raise the control arm and move to the right above rest-post.

## CUEING LEVER AND PAUSE CONTROL (Refer to Fig. 1)

This useful device allows you to raise and lower the tone arm under positive control at any desired point on the record. To raise tone arm, move cueing lever to its maximum up position, indicated by "▲". You may then position stylus over any desired band. Lower the tone arm by moving cueing lever to position indicated by "▼". The viscous damped cueing device will gently lower the tone arm to the selected groove. This same procedure can be followed for "PAUSE" when you wish to interrupt play and then return stylus to the same groove.

**IMPORTANT:** During automatic play, cueing lever must be in "DOWN" "▼" position.